



## FEATURES

- 10 WATTS OUTPUT POWER
- OUTPUT CURRENT UP TO 2.5A
- STANDARD 2.0 X 1.0 X 0.4 INCH PACKAGE
- HIGH EFFICIENCY UP TO 87%
- 2:1 AND 4:1 WIDE INPUT VOLTAGE RANGE
- SIX-SIDED CONTINUOUS SHIELD
- FIXED SWITCHING FREQUENCY (300KHz)
- CE MARK MEETS 2006/95/EC, 93/68/EEC AND 2004/108/EC
- UL60950-1, EN60950-1 AND IEC60950-1 LICENSED
- ISO9001 CERTIFIED MANUFACTURING FACILITIES
- COMPLIANT TO RoHS EU DIRECTIVE 2002/95/EC

## APPLICATIONS

Wireless Network  
Telecom/Datacom  
Industry Control System  
Measurement Equipment  
Semiconductor Equipment

## OPTIONS

NEGATIVE & POSITIVE LOGIC REMOTE ON/OFF

## DESCRIPTION

The FDC10 and FDC10-W series offer 10 watts of output power from a 2.0 x 1.0 x 0.4 inch package. FDC10 series have 2:1 wide input voltage of 9 ~ 18, 18 ~ 36 and 36 ~ 75VDC. FDC10-W series have 4:1 ultra wide input voltage of 9 ~ 36 and 18 ~ 75VDC.

## TECHNICAL SPECIFICATION

All specifications are typical at nominal input, full load and 25°C otherwise noted.

OUTPUT SPECIFICATIONS			
Output power			10 Watts, max.
Voltage accuracy		Single / Dual	± 1%
Minimum load			0%
Line regulation	LL to HL at Full Load	Single / Dual	± 0.2%
Load regulation	No Load to Full Load	Single Dual	± 0.5% ± 1%
Cross regulation(Dual)	Asymmetrical load 25% / 100% FL		± 5%
Ripple and noise	20MHz bandwidth	Single Dual	See table
Temperature coefficient			±0.02% / °C, max.
Transient response recovery time	25% load step change		250µs
Over voltage protection	3.3VDC output		3.9VDC
	5VDC output		6.2VDC
	Zener diode clamp	12VDC output 15VDC output	15VDC 18VDC
Over load protection	% of FL at nominal input		150%, max.
Short circuit protection			Hiccup, automatics recovery
GENERAL SPECIFICATIONS			
Efficiency			See table
Isolation voltage	Input to Output	1600VDC, min.	1minute
	Input(Output) to Case	1600VDC, min.	1minute
Isolation resistance		10 <sup>9</sup> ohms, min.	
Isolation capacitance		300pF, max.	
Switching frequency		300KHz±10%	
Approvals and standard		IEC60950-1, UL60950-1, EN60950-1	
Case material		Nickel-coated copper	
Base material		Non-conductive black plastic	
Potting material		Epoxy (UL94-V0)	
Dimensions		2.00 X 1.00 X 0.40 Inch (50.8 X 25.4 X 10.2 mm)	
Weight		27g (0.95oz)	
MTBF (Note 1)	BELLCORE TR-NWT-000332	1.976 x 10 <sup>6</sup> hrs	
	MIL-HDBK-217F	1.416 x 10 <sup>6</sup> hrs	

INPUT SPECIFICATIONS			
Input voltage range	FDC10	12VDC nominal input	9 ~ 18VDC
		24VDC nominal input	18 ~ 36VDC
		48VDC nominal input	36 ~ 75VDC
	FDC10-W	24VDC nominal input	9 ~ 36VDC
		48VDC nominal input	18 ~ 75VDC
Input filter			Pi type
Input surge voltage		12VDC input	36VDC 100mS, max.
		24VDC input	50VDC 100mS, max.
		48VDC input	100VDC 100mS, max.
Input reflected ripple current			30mA p-p
Start up time	Nominal input and		Power up
	Constant resistive load		
Remote ON/OFF (Option) (Note 6)			
(Positive logic)	DC-DC ON		Open or 3.5V < Vr < 12V
	DC-DC OFF		Short or 0V < Vr < 1.2V
(Negative logic)	DC-DC ON		Short or 0V < Vr < 1.2V
	DC-DC OFF		Open or 3.5V < Vr < 12V
Input current of remote control pin	Nominal input		-0.5mA ~ +1mA
Remote off state input current	Nominal input		20mA

ENVIRONMENTAL SPECIFICATIONS			
Operating ambient temperature (Reference derating curve)	Standard	-25°C ~ +85°C (with derating)	
	M1 (Note 7)	-40°C ~ +85°C (non-derating)	
	M2 (W series)	-40°C ~ +85°C (with derating)	
Maximum case temperature			+100°C
Storage temperature range			-55°C ~ +105°C
Thermal impedance (Note 8)	Nature convection		12°C/watt
	Nature convection with heat-sink		10°C/watt
Thermal shock			MIL-STD-810F
Vibration			MIL-STD-810F
Relative humidity			5% to 95% RH

EMC CHARACTERISTICS			
EMI (Note 9)	EN55022		Class A
ESD	EN61000-4-2	Air	± 8KV
		Contact	± 6KV
Radiated immunity	EN61000-4-3	10 V/m	Perf. Criteria A
Fast transient (Note 10)	EN61000-4-4	± 2KV	Perf. Criteria B
Surge (Note 10)	EN61000-4-5	± 1KV	Perf. Criteria B
Conducted immunity	EN61000-4-6	10 Vr.m.s	Perf. Criteria A





Model Number	Input Range	Output Voltage	Output Current		Output (4) Ripple & Noise	Input Current		Eff (4) (%)	Capacitor(5) Load max
			Min. load	Full load		No load (3)	Full load (2)		
FDC10-12S33	9 ~ 18 VDC	3.3 VDC	0mA	2000mA	50mVp-p	17mA	724mA	80	6800μF
FDC10-12S05	9 ~ 18 VDC	5 VDC	0mA	2000mA	50mVp-p	21mA	1082mA	81	4700μF
FDC10-12S12	9 ~ 18 VDC	12 VDC	0mA	830mA	50mVp-p	38mA	1037mA	84	690μF
FDC10-12S15	9 ~ 18 VDC	15 VDC	0mA	670mA	50mVp-p	36mA	1046mA	84	470μF
FDC10-12D05	9 ~ 18 VDC	± 5 VDC	0mA	± 1000mA	75mVp-p	39mA	1042mA	84	± 680μF
FDC10-12D12	9 ~ 18 VDC	± 12 VDC	0mA	± 416mA	75mVp-p	47mA	1053mA	83	± 330μF
FDC10-12D15	9 ~ 18 VDC	± 15 VDC	0mA	± 333mA	75mVp-p	45mA	1041mA	84	± 110μF
FDC10-24S33 (W)	18 ~ 36 (9 ~ 36) VDC	3.3 VDC	0mA	2000(2500mA)	50mVp-p	15(13mA)	362(465mA)	80(78)	6800μF
FDC10-24S05 (W)	18 ~ 36 (9 ~ 36) VDC	5 VDC	0mA	2000mA	50mVp-p	22(11mA)	534 (548mA)	82 (80)	4700μF
FDC10-24S12 (W)	18 ~ 36 (9 ~ 36) VDC	12 VDC	0mA	830mA	50mVp-p	18(16mA)	519 (519mA)	84 (84)	690μF
FDC10-24S15 (W)	18 ~ 36 (9 ~ 36) VDC	15 VDC	0mA	670mA	50mVp-p	36(26mA)	523 (544mA)	84 (81)	470μF
FDC10-24D05 (W)	18 ~ 36 (9 ~ 36) VDC	± 5 VDC	0mA	± 1000mA	75mVp-p	28(15mA)	527 (534mA)	83 (82)	± 680μF
FDC10-24D12 (W)	18 ~ 36 (9 ~ 36) VDC	± 12 VDC	0mA	± 416mA	75mVp-p	24(15mA)	513 (547mA)	85 (80)	± 330μF
FDC10-24D15 (W)	18 ~ 36 (9 ~ 36) VDC	± 15 VDC	0mA	± 333mA	75mVp-p	31(22mA)	520 (548mA)	84 (80)	± 110μF
FDC10-48S33 (W)	36 ~ 75 (18 ~ 75) VDC	3.3 VDC	0mA	2000(2500mA)	50mVp-p	11(10mA)	181(239mA)	80(76)	6800μF
FDC10-48S05 (W)	36 ~ 75 (18 ~ 75) VDC	5 VDC	0mA	2000mA	50mVp-p	14(9mA)	260 (270mA)	84 (81)	4700μF
FDC10-48S12 (W)	36 ~ 75 (18 ~ 75) VDC	12 VDC	0mA	830mA	50mVp-p	14(9mA)	253 (259mA)	86 (84)	690μF
FDC10-48S15 (W)	36 ~ 75 (18 ~ 75) VDC	15 VDC	0mA	670mA	50mVp-p	10(11mA)	252 (262mA)	87 (84)	470μF
FDC10-48D05 (W)	36 ~ 75 (18 ~ 75) VDC	± 5 VDC	0mA	± 1000mA	75mVp-p	16(12mA)	260 (267mA)	84 (82)	± 680μF
FDC10-48D12 (W)	36 ~ 75 (18 ~ 75) VDC	± 12 VDC	0mA	± 416mA	75mVp-p	19(20mA)	254 (281mA)	86 (78)	± 330μF
FDC10-48D15 (W)	36 ~ 75 (18 ~ 75) VDC	± 15 VDC	0mA	± 333mA	75mVp-p	16(20mA)	256 (270mA)	85 (81)	± 110μF

**Note**

- BELLCORE TR-NWT-000332. Case 1: 50% Stress, Temperature at 40°C. MIL-HDBK-217F Notice2 @Ta=25 °C, Full load(Ground, Benign, controlled environment).
- Maximum value at nominal input voltage and full load of standard type.
- Typical value at nominal input voltage and no load.
- Typical value at nominal input voltage and full load.
- Test by minimum input and constant resistive load.
- The ON/OFF control pin voltage is referenced to -INPUT  
To order positive logic ON/OFF control add the suffix-P (Ex: FDC10-12S05-P); To order negative logic ON-OFF control add the suffix-N (Ex: FDC10-12S05-N)
- M1 version is more efficient, therefore, it can be operated in a more extensive temperature range than standard and M2 version.
- Heat-sink is optional and P/N: 7G-0020C-F.
- The FDC10 series can meet EN55022 Class A with parallel an external capacitor to the input pins.  
Recommend: 12Vin : 4.7μF/25V 1210 MLCC .  
24Vin : 2.2μF/50V 1812 MLCC .  
48Vin : 1.5μF/100V 1812 MLCC .
- An external input filter capacitor is required if the module has to meet EN61000-4-4, EN61000-4-5. The filter capacitor Power Mate suggest: Nippon chemi-con KY series, 220 μF/100V, ESR 48mΩ.

**CAUTION:** This power module is not internally fused. An input line fuse must always be used.

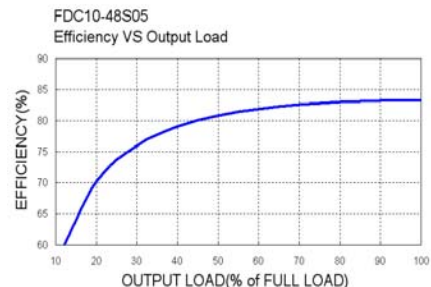
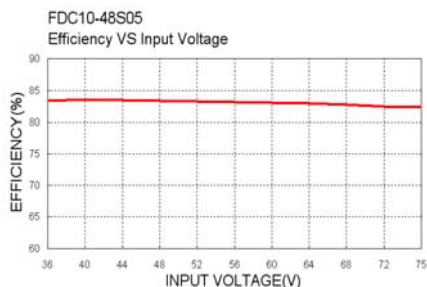
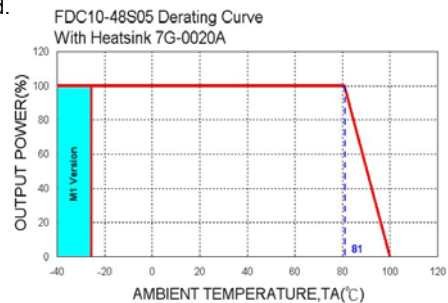
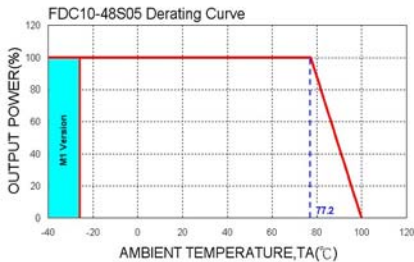

**Mechanical Drawing:**

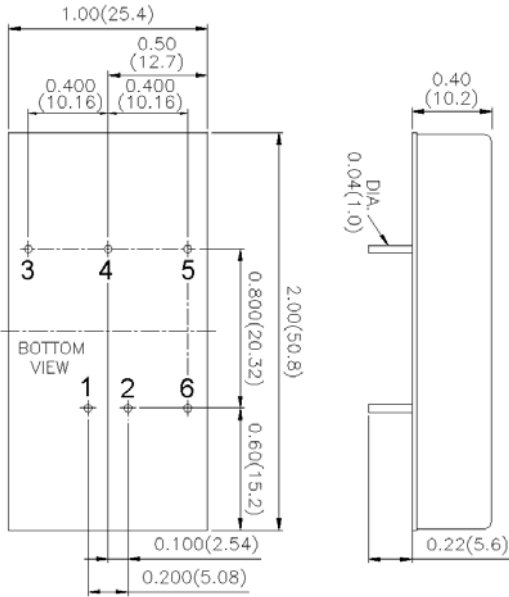

- All dimensions in Inch (mm)  
Tolerance: X.XX±0.02 (X.X±0.5)  
X.XXX±0.01 (X.XX±0.25)
- Pin pitch tolerance ±0.01(0.25)
- Pin dimension tolerance ±0.004 (0.1)

PIN CONNECTION		
PIN	SINGLE	DUAL
1	+ INPUT	+ INPUT
2	- INPUT	- INPUT
3	+ OUTPUT	+ OUTPUT
4	NO PIN	COMMON
5	- OUTPUT	- OUTPUT
6	CTRL (Option)	CTRL (Option)

**Recommended EMI Filter:**

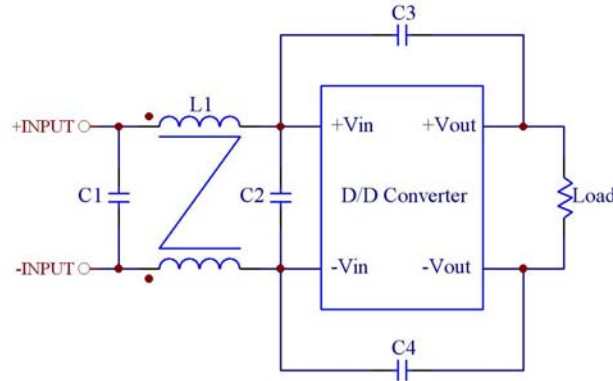

**Recommended Filter for EN55022 Class B Compliance**

The components used in the above figure, together with the manufacturers' part numbers for these components, are as follows:

	C1	C2	C3	C4	L1
FDC10-12xxx	3.3µF/50V 1812 MLCC	N/A	1000P/2KV MLCC	1000P/2KV MLCC	325µH Common Choke PMT-050
FDC10-24xxx	2.2µF/50V 1812 MLCC	N/A	1000P/2KV MLCC	1000P/2KV MLCC	325µH Common Choke PMT-050
FDC10-48xxx	2.2µF/100V 1812 MLCC	2.2µF/100V 1812 MLCC	1000P/2KV MLCC	1000P/2KV MLCC	325µH Common Choke PMT-050

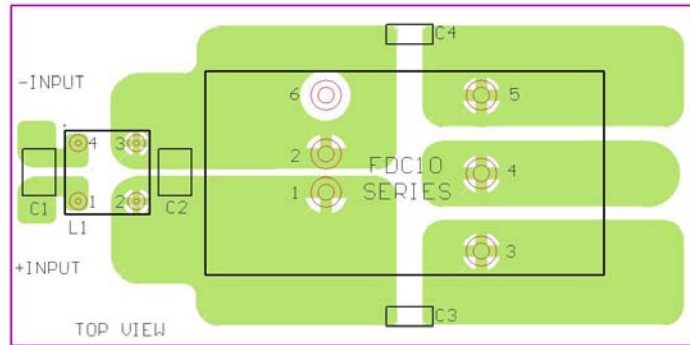

**Recommended EN55022 Class B Filter Circuit Layout**